

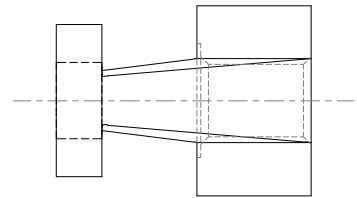

A

B

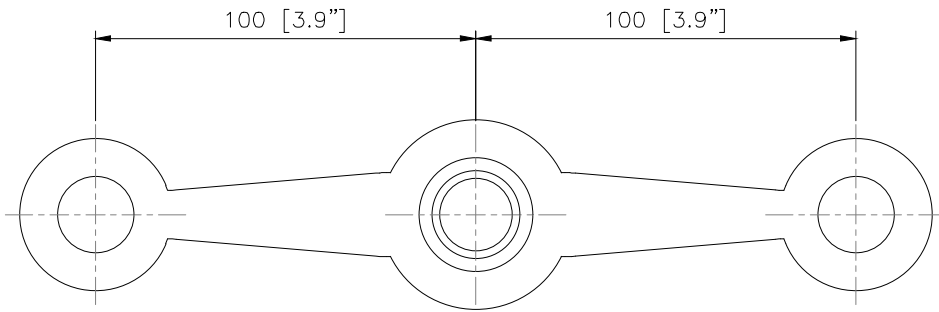
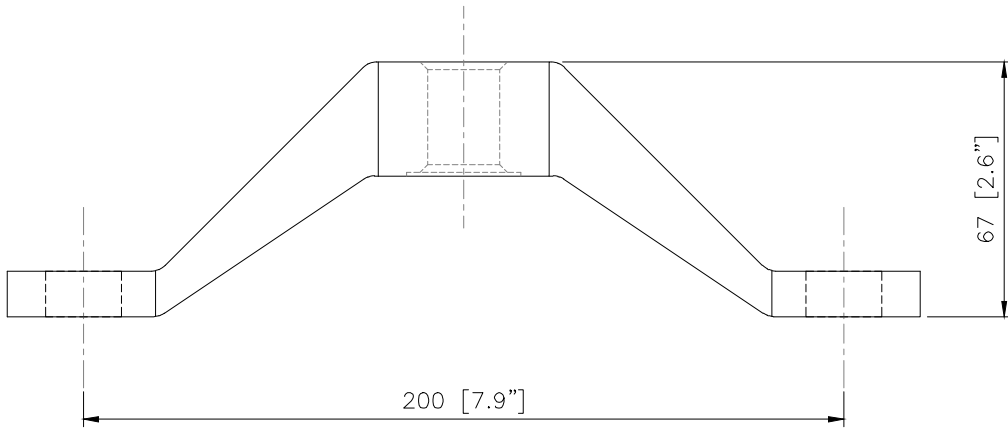

11-2-180	
MATERIAL: (options)	316 STAINLESS STEEL 2205 DUPLEX STAINLESS STEEL
FINISH: (options)	BRUSHED FINISH POLISHED FINISH PAINTED FINISH
ADDITIONAL OPTIONS:	ANTI-ROTATION PIN

NUPRESS GROUP NORTH AMERICA	
	NUPRESS FACADES
Part No:	11-2-180

A

B