

A

B

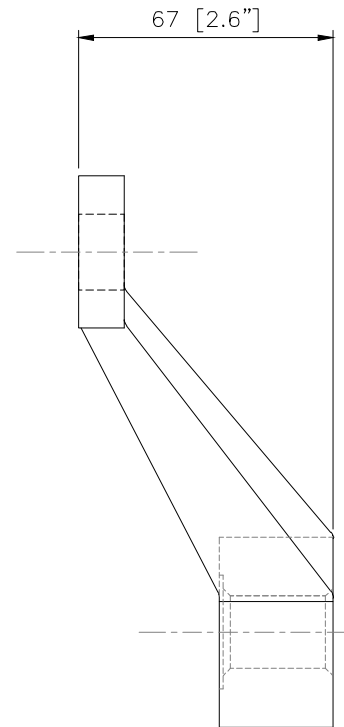
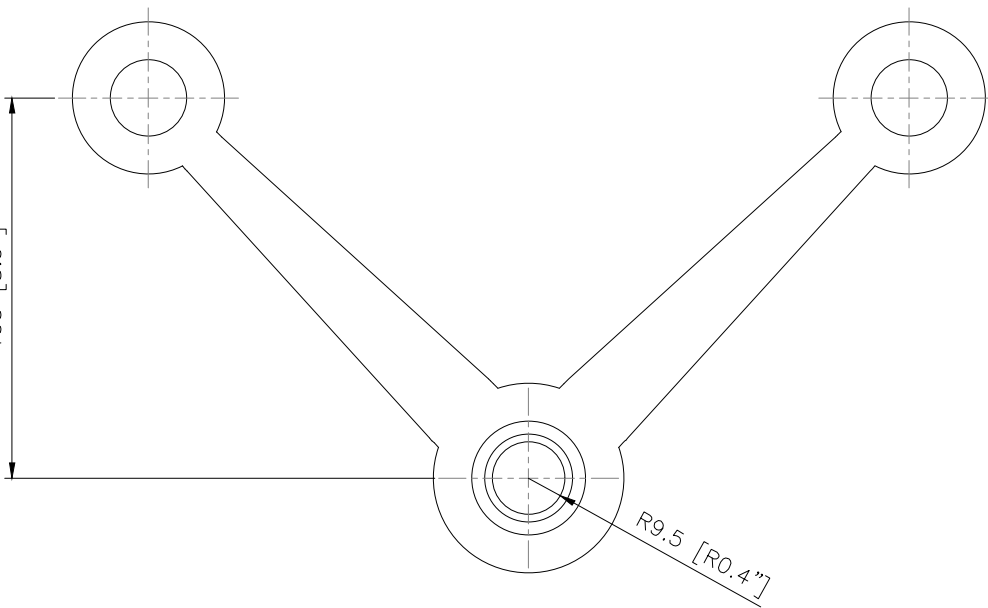
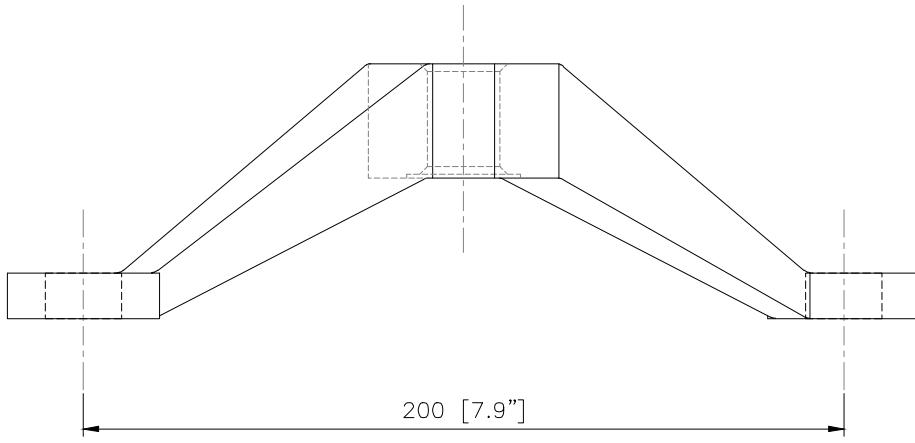

11-2-90	
MATERIAL: (options)	316 STAINLESS STEEL 2205 DUPLEX STAINLESS STEEL
FINISH: (options)	BRUSHED FINISH POLISHED FINISH PAINTED FINISH
ADDITIONAL OPTIONS:	ANTI-ROTATION PIN

NUPRESS GROUP NORTH AMERICA	
	NUPRESS FACADES
Part No:	11-2-90

A

B