

A

B

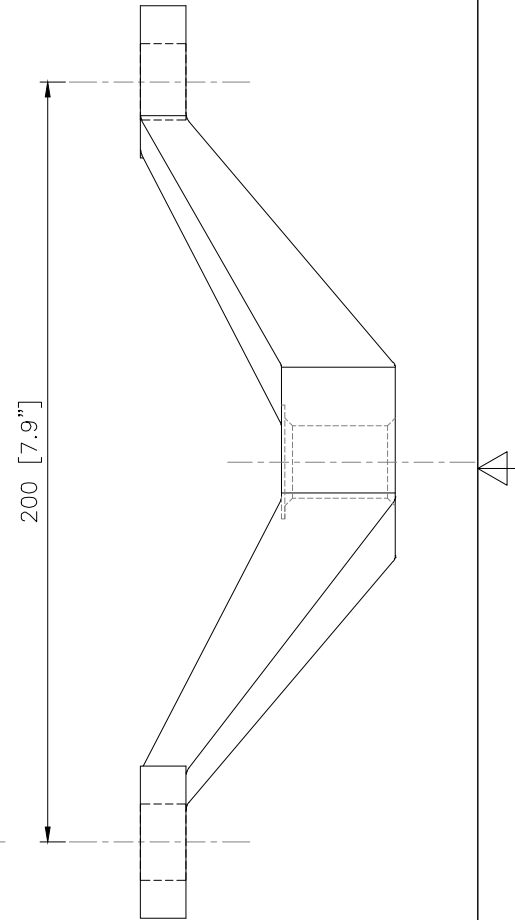
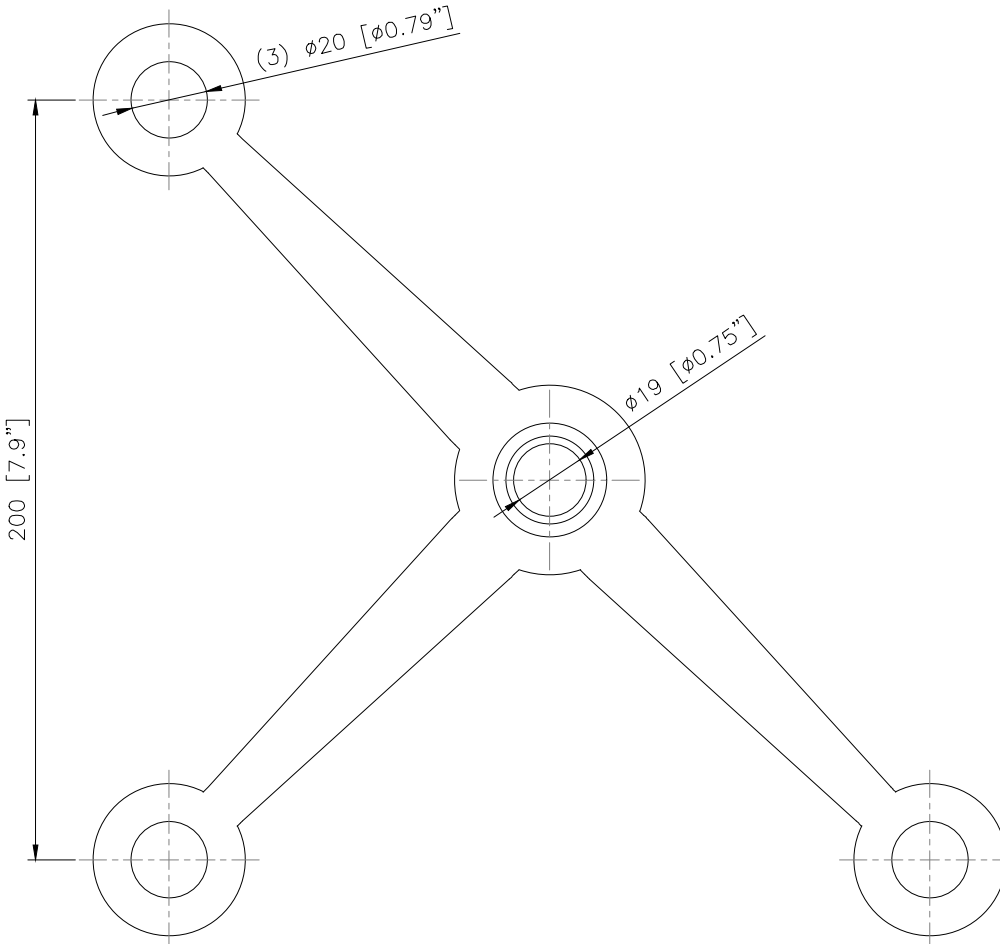
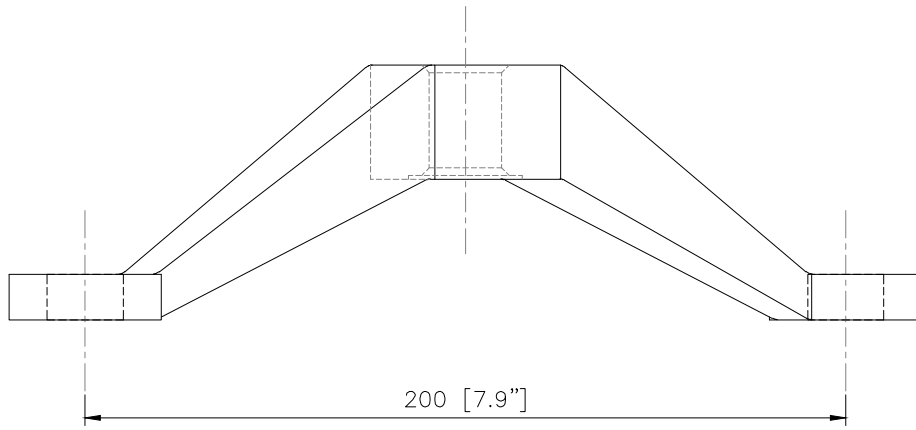

11-3-90

MATERIAL: (options)

316 STAINLESS STEEL
2205 DUPLEX STAINLESS STEEL

FINISH: (options)

BRUSHED FINISH
POLISHED FINISH
PAINTED FINISHADDITIONAL
OPTIONS:

ANTI-ROTATION PIN

NUPRESS GROUP NORTH AMERICA



NUPRESS | FACADES

Part No:

11-3-90

A

B